



STEP 1 – PRIOR TO INSTALLATION

- A) Husky®** only approves installing the flares according to these written instructions with the hardware provided. **WARNING:** Failure to install according to these instructions will invalidate the warranty. This includes, but is not limited to using alternative installation methods, hardware, or materials. **DO NOT USE:** Loctite, SuperGlue, or similar products on the hardware or the flares.
- B) Fit:** Verify the fit of the flares to vehicle. (Some filing, sanding, or cutting may be necessary to ensure proper fit).
- C) Painting:** (Optional) if paint is desired it must be done prior to installing flares on vehicle. Clean outer surface with a good grade degreaser. **DO NOT USE LACQUER THINNER OR ENAMEL REDUCER AS A DEGREASER.** Wipe outer surface thoroughly with a tack rag prior to paint. Application of plastic adhesion promoter for ABS plastic as per your paint system manufacturer’s recommendations is required. Paint flares using a high quality enamel, or polyurethane automotive paint. If painting edge trim (not recommended), use a flex additive.
- D) Performance:** Using larger Tires may increase the area required to turn the vehicle. Some Tire/Rim combinations may require lowering bump stops and or installing steering stops to prevent tire from contacting flare.
- E) Exhaust System:** Modifications may be necessary to maintain a minimum 4” clearance between flares and exhaust pipes. (Exhaust gases should not vent directly onto flares)
- F) Metal Protection:** All exposed fasteners and bare metal should be treated with rust resistant paint **BEFORE** installing flares. Spray inner fender wells with undercoating **AFTER** flare attachments have been completed.
- G) Decals:** Flares may interfere with existing decals on vehicle. If you wish, remove decals prior to installation of flares.
- H) Care & Cleaning:** Husky fender flares are built to last; any detergent you use to wash your vehicle is sufficient to clean the flare. Do not use any harsh abrasive detergents.

Chevrolet 1500 OE Style® Fender Flares Set of 4

Set Part #2804996
Rev-0 08/24/2023

TOOLS FOR EASY INSTALLATION:

- Utility Knife
- #2 Phillips Driver
- Socket Wrench
- 10mm Socket
- T15 Torx Bit
- Awl or Similar Pointed Tool
- Grease Pencil
- Pliers

PLEASE READ: Dirt and debris can become lodged between the fender flares and the vehicle’s fenders, causing scratching and paint wear from vibration. Husky Liners is not responsible for any damage, and the installation of our fender flares is done with the buyer’s understanding that this scratching and paint wear may occur.

LIMITED LIFETIME WARRANTY AGAINST ANY MANUFACTURING DEFECTS











- To claim a warranty, you must provide Proof of Purchase.

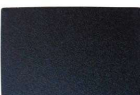

The material that your product is made from can be recycled. Please also consider recycling the packaging that your product came in.



Included in Hardware Kit:

- | | | | | | | |
|--|--|--|---|---|---|--|
| <p>1. 
CL1-0009,
Long “U” Clip,
Magni 565
12 pcs</p> | <p>2. 
SW1-0058,
#10 x 5/8” Phillips
SS Truss Screw,
12 pcs</p> | <p>3. 
MT1-0034,
1” x1.5” x.06”
Blk 3M Foam Tab,
12 pcs</p> | <p>4. 
SW1-0049,
10 x 3/4” Phillips
Tapping Screw,
2 pcs</p> | <p>5. 
MT1-0017,
1” x1.5” x.002”
Clear Tab,
2 pcs</p> | <p>6. 
CL1-0008,
1” Dacromet
Inner Clip,
2 pcs</p> | <p>7. 
CL1-0010,
Dacromet Outer
Clip,
2 pcs</p> |
| <p>8. 
ET1-0002,
Edge Trim Tool,
1 pc</p> | <p>9. 
GP1-0025,
Edge Trim
360 inches</p> | <p>10. 
AD1-0008,
ALCOHOL PREP
PAD,
2 pcs</p> | | | | |

If your flares already have the edge trim installed, skip to Front Flare Installation Step 1.

STEP 2 - EDGE TRIM INSTALLATION

- A)** Peel two to three inches of red vinyl backing away from Edge Trim (GP1-0025) tape. Applying the adhesive side of the edge trim to the inner side of the flare, affix the edge trim to the top edge of the flare (the portion that comes in contact with the vehicle).
- B)** Press edge trim into place along the top edge of the flare in one-foot increments, pulling red vinyl backing free as you continue to work your way around the top edge of the flare.
- C) FRONT FLARES ONLY:** The edge trim must be cut to prevent bunching and stretching at the forward end of the part where the flare goes along the headlight.



Front Flare Installation Procedures (Passenger's Side):



Locate the factory installed mud flap on the passenger side front wheel well.

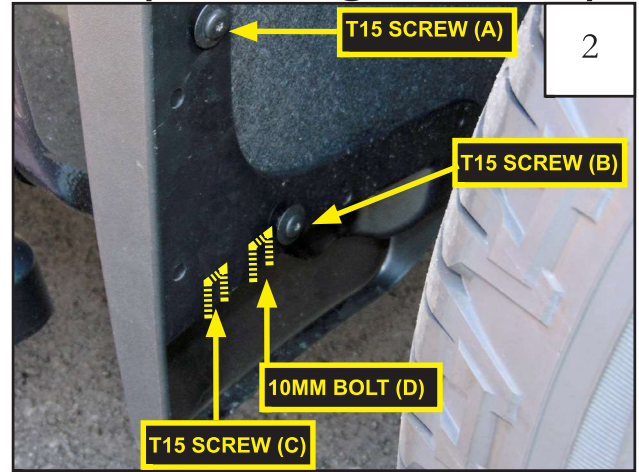

Remove (3) factory installed T15 screws, and (1) factory installed 10mm bolt. Note that two T15 screws labeled (A) and (B) above will be re-used to install the flare. You may discard (C) and (D).

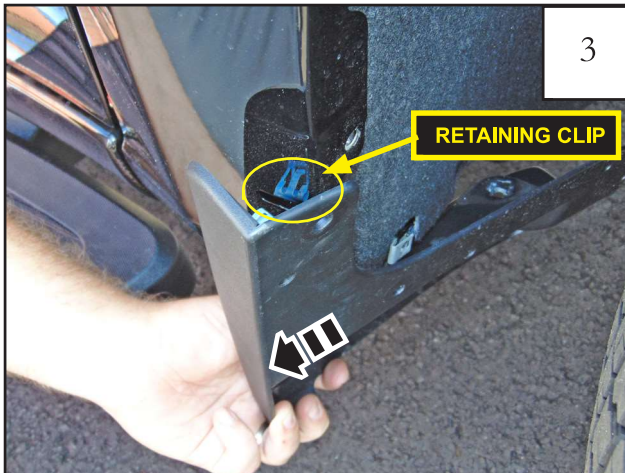

Firmly pull the mud flap away from vehicle in order to disengage the factory retaining clip, and remove mudflap from vehicle. If necessary, pliers may be needed to squeeze clip from behind.



Remove (3) factory installed T15 screws from wheel well as shown above. These screws will be re-used to install the front flare.



Hold flare to vehicle and note the approximate hole locations in the flare.

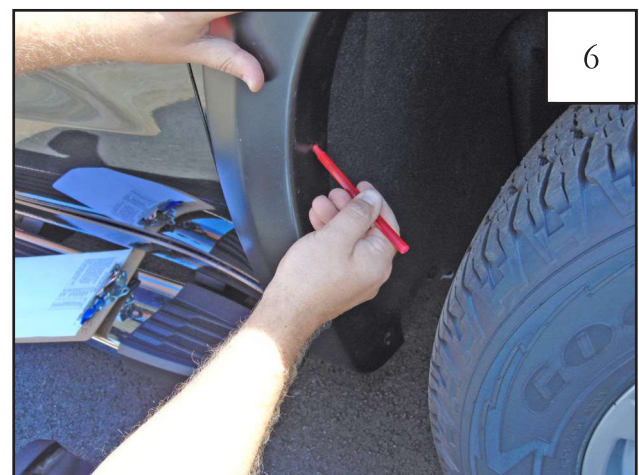

Use a grease pencil to mark the two locations of the holes indicated with the circles in Step 5. Remove flare from vehicle.

Front Flare Installation Procedures (Passenger's Side):

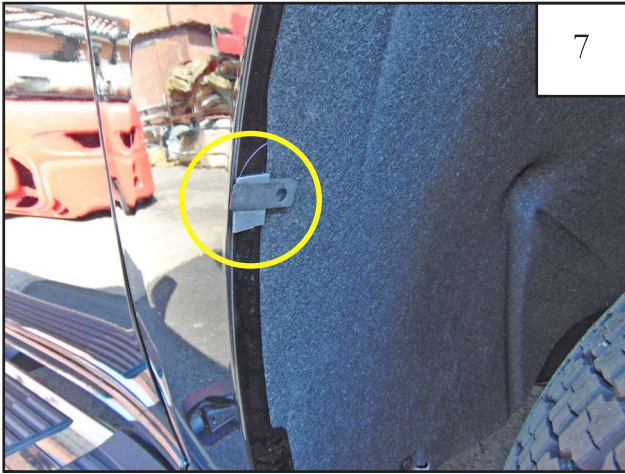

Install supplied Tab (MT1-0034) over the rear location marked in Step 6. Install a Clip (CL1-0009) as indicated on top of the protective film.



For model years 2022+ vehicles, peel back 2 inches of tape on supplied inner bracket - If older than 2022 – proceed to Step 12



Clean Fascia piece with supplied alcohol pad and let dry.



Line up the U-clip hole on the inner bracket to the mark made in Step 5 and install the inner bracket.

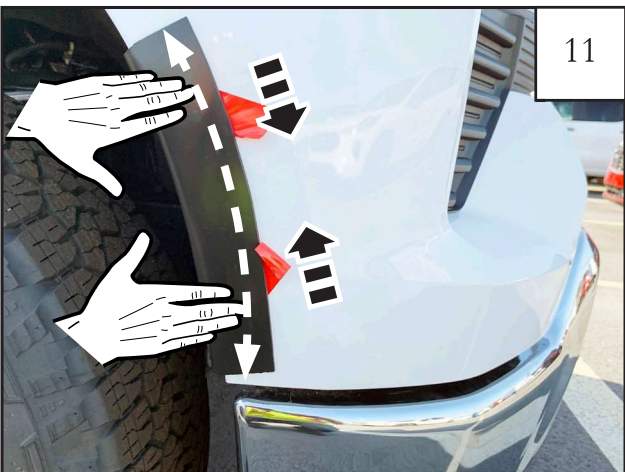

Remove tape liner and firmly press down on inner bracket to insure good adhesion. (Proceed to Step 15)

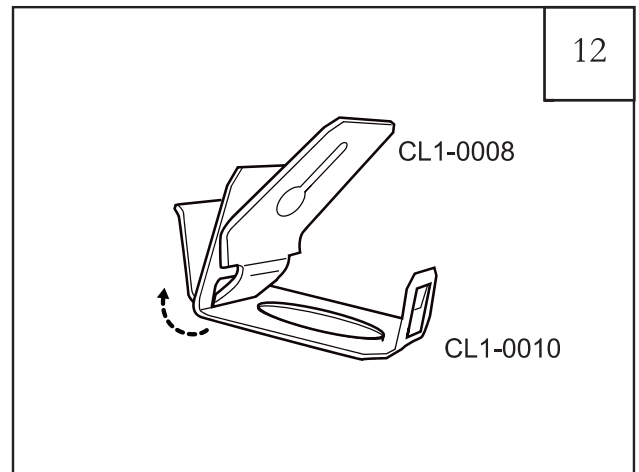

Assemble Clip CL1-008 with CL1-0010 as indicated in the above diagram. Insert tab of CL1-0008 through slot in CL1-0010.

Front Flare Installation Procedures (Passenger's Side):

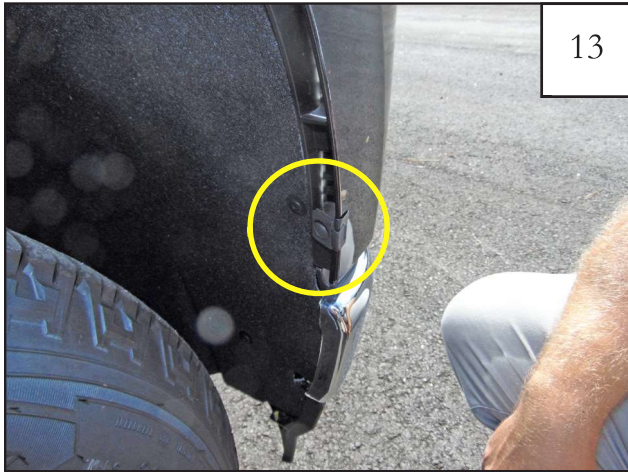

Install supplied Tab (MT1-0017) over the front location marked in Step 6. Install a clip assembly as indicated, on top of the Tab. See Step 10 for detail of clip attachment.

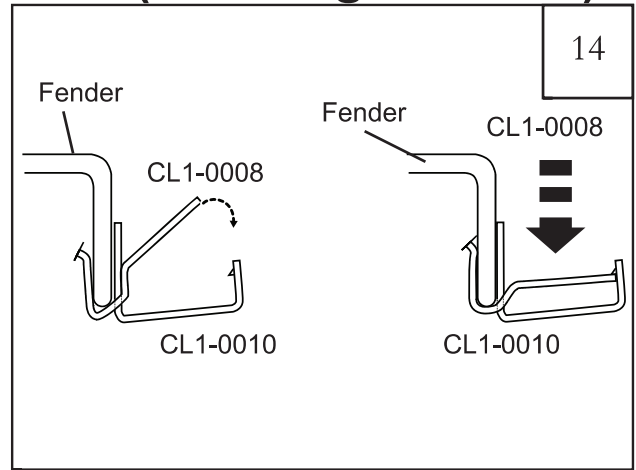

Press down on CL1-0008 as indicated until an audible "snap" is heard. NOTE: This may require pliers.



Hold flare to vehicle and re-install (3) factory screws (removed in Step 4) with a T15 bit. *Do not tighten.*



Re-install (2) factory screws (removed in Step 2) with a T15 bit. *Do not tighten.*



Install (1) supplied phillips head screw (SW1-0058) at rear Clip location. *Do not tighten.* (If needed use an awl to align flare mounting holes.)



Install (1) supplied Phillips head screw (SW1-0049) at front clip/inner bracket location. *Do not tighten.* (If needed use an awl to align flare mounting holes.)

Front Flare Installation Procedures (Passenger's Side)



Press flare firmly against body and tighten all screws.



Completed front flare installation.

Rear Flare Installation Procedures (Passenger's Side)

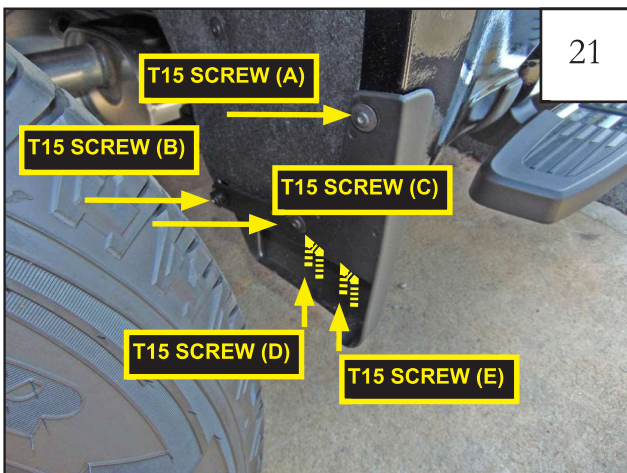

Locate the mud flap in front of the rear wheel. Remove (5) factory installed T15 screws. Note that T15 screws labeled (A) and (C) will be re-used to install the flare. You may discard (B), (D), and (E).

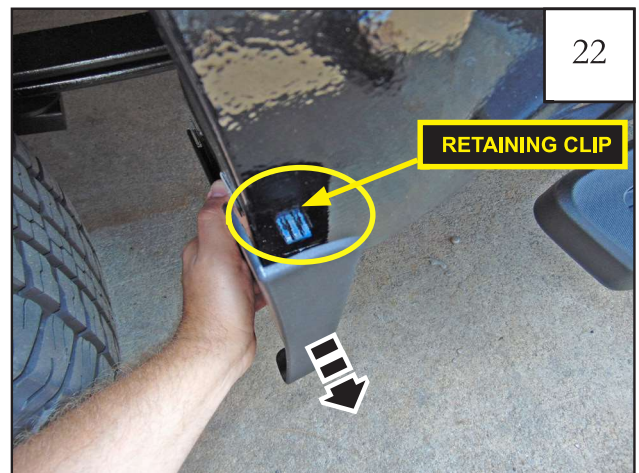

Firmly pull the mud flap away from vehicle in order to disengage the factory retaining clip, and remove mudflap from vehicle. If necessary, pliers may be needed to squeeze clip from behind.

Rear Flare Installation Procedures (Passenger's Side)



Locate the mud flap behind the rear wheel. Remove (2) factory installed T15 screws. These screws will be re-used to install the flare.



Hold flare to vehicle and note the approximate hole locations in the flare.

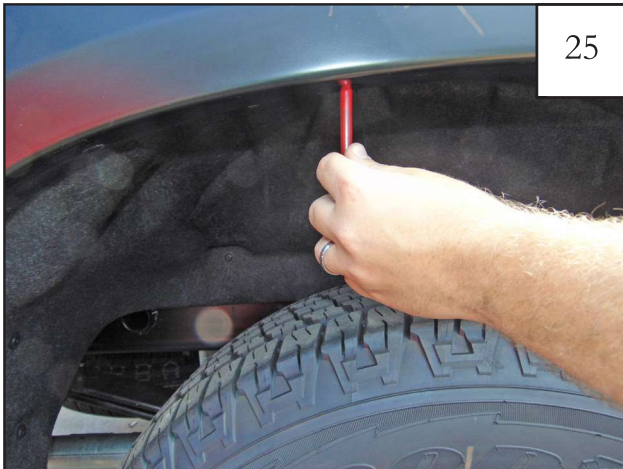

Use a grease pencil to mark the five locations of the holes indicated by the circles in Step 20. Remove flare from vehicle.



Install supplied Tab (MT1-0034) at each location marked in Step 21.



Install a supplied Clip (CL1-0009) over each Tab (MT1-0034).



Hold flare to vehicle and install (5) supplied phillips head screws (SW1-0058) at each Clip location. *Do not tighten.* (If needed use an awl to align flare mounting holes.)

Rear Flare Installation Procedures (Passenger's Side):



Re-install (4) factory T15 screws as indicated above. Do not tighten.



Press flare firmly against body and tighten all screws.



Completed rear flare installation.

Edge Trim Tool Procedures:

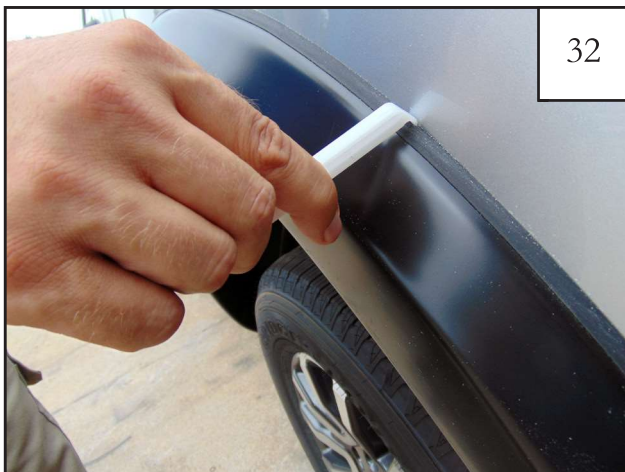

Using supplied Edge Trim Tool (ET1-0002), seat edge trim against vehicle by hooking curved end under edge trim at one end of flare. Next, slide around outer edge of flare to the other end.



Using flat end of supplied Edge Trim Tool (ET1-0002), seat edge trim against flare by inserting straight end between edge trim and flare at one end. Next, slide around entire edge to the other end.